

LTE-R5-DIN

1. Introduction

The LTE-R5-DIN (*GSM rele⁵* for short) is designed to be mounted on a DIN rail into a switchboard. *GSM rele⁵* can control two independent electrical circuits in a building e.g. circuit of an accumulator stove and circuit for garage gate control. The control is made via SMS messages or by mobile application. After installation into an electrical box insert a SIM card of any GSM operator and the device is ready to operate.

The *GSM rele⁵* has 2 digital outputs (Y5, Y6) with a relay, which can control directly power circuits up to 230 V_{AC}/5 A. It's possible to control directly e.g. a thermoregulator circuit of a gas boiler or a coil of one phase contactor 230V AC. The contact of the contactor can then control either one phase high power appliance (e.g. electrical radiator) or a coil of three phase contactor of an accumulation stove.

The *GSM rele⁵* has also 2 digital inputs (X1, X2) and 2 analog inputs (A3, A4). Digital inputs are determined for potential free contacts. Analog inputs can be used for measuring the temperature, current or voltage. *GSM rele⁵* has built in two automatic regulators which use analog inputs from temperature sensors to maintain preset temperature. The temperature of sensors can be readout via SMS.

There is an internal built in Li-POL accumulator which allows to send an SMS in case of a power failure and to restore the output status after a power failure. It's also possible to monitor the status of inputs and temperatures via SMS during 230 V_{AC} power failure.

Internal data logger keeps records about events and valued of inputs.

- ① - device state indication
- ② - OUTPUT Y5, Y6 connectors
- ③ - 230V_{AC} Power supply connector
- ④ - Push buttons, local control from Y5, Y6
- ⑤ - OUTPUT Y5, Y6 state indication
- ⑥ - INPUT X1, X2 connectors
- ⑦ - ANALOG INPUT A3, A4 connectors
- ⑧ - GSM antenna connector
- ⑨ - USB connector (for configuration)
- ⑩ - nano SIM card holder

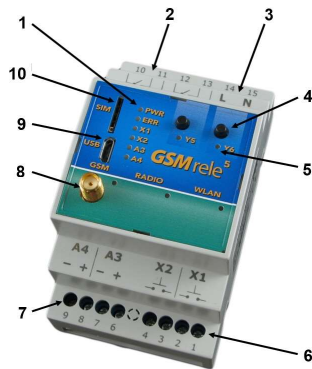

2. Package Content

- 1 pc *GSM rele⁵* (order code LTE-R5-DIN)
- 1 pc GSM antenna ANT05S (order code GSM-ANT05S)
- 1 pc temperature sensor GSM-C-T2 (based on KTY81-210), cable - 1 meter



3. Installation

1. To operate the *GSM rele⁵* a SIM card of any GSM operator is necessary. SIM card must be functional and active. Also some credit is necessary if SIM card is pre-paid. We recommend to deactivate the PIN code for installation.
2. The SIM card holder can accommodate nano SIM card only (12,3 x 8,8

1. Before inserting the SIM card into the *GSM rele⁵* device, we recommend to turn off setting of the "PIN code"!

2. Insert the active SIM card (= at least one call was made) to any mobile telephone and turn off the requirement of setting the PIN. On most mobile telephones, this option can be found in menu "Setting the telephone protection". or "Setup -> Security -> PIN control".

ATTENTION:

3. *GSM rele⁵* must be mounted by qualified personnel only!

mm).

3. Insert this prepared SIM card (cut off corner first) into a SIM card holder. The proper insertion is indicated by a slight mechanical click noise. To remove the SIM card - press the SIM card in direction into the *GSM rele⁵* until mechanical click. The SIM card can be the freely removed.



4. Now it's possible to connect the device to 230V AC power supply. If the power supply is correct, green LED PWR goes on and blue LED GSM is flashing slowly. After about 20 seconds, blue LED diode GSM starts flashing with a period 1 per 3 sec. (registered).

5. For the first tests of *GSM rele⁵* the connection of inputs and outputs is not important. Please keep in mind that the devices connected to OUTPUTS will be switched on during tests!

6. To test the *GSM rele⁵* press the push button bellow Y5 for a local control. The yellow LED diode for Y5 lights ON and relay for output Y5 switch on. Send an SMS from mobile phone (which will be mainly used to control the *GSM rele⁵*) in form 1234 OFF to the telephone number of the SIM card inserted into the *GSM rele⁵*. This will switch off output Y5 and the yellow status LED for Y5 goes OFF. Simultaneously, the device automatically sends a confirmation SMS message on performing the operation. The password 1234 can be changed later in configuration. The *GSM rele⁵* reacts on the SMS text message from any telephone as long as the access password matches. The very first one (the sender of the first

valid SMS message) will be remembered as master and will receive messages about events on *GSM rele⁵*.

7. Try pulse. You can make pulse on Y6 for approx. 4 seconds by sending SMS in format 1234 PULSE to *GSM rele⁵* (with default factory setting). The device makes pulse on the Y6. This pulse can be used for example for opening entrance gate. The pulse is indicated by yellow LED below Y6 push button.

8. Try regulation. By default the regulation of Y5 depends on temperature sensor connected to analog input A3. So connect a temperature sensor into a analog input A3. Send SMS in form of 1234 Y5 REG 25 to command the device to maintain temperature to 25°C. The range of regulation is between 0°C and +55°C. Regulation can be canceled by SMS with command 1234 Y5 OFF.

9. A default factory setting of the *GSM rele⁵* can be recovered by an SMS in form 1234 IFACTORY. If you made a backup configuration in *SeaConfigurator*, your setting can be then restored from backup configuration of *SeaConfigurator* program.

10. Names of input, outputs (and its states) and names of commands is possible to change in *SeaConfigurator* program. Visit www.seapraha.cz for download it for free and install the program to your PC.

4. Technical Specifications

Parameter	Symbol	Cond.	MIN.	TYP.	MAX.	Units
Dimensions	Width	W		52		mm
	Height	H		90		mm
	Depth	D		66		mm
Power supply *1)	Voltage	V	180	230	250	V AC
	Consumption			1	2	W
Backup power supply		integrated		1		day
Digital inputs	X1, X2 – potential free contact					
Digital outputs	Y5, Y6 – relay					
	Voltage	V _{OUT}			250	V AC
	Current	I _{OUT}			30	V DC
Analog inputs	Power				5	A
	A3, A4 - set by user as: Voltage 0-10V; Current 0-20mA (input resistance 75Ω); temperature for sensors: KTY (-50 to +150°C); Pt100 (-100 to +300°C); Pt1000 (-100 to +300°C)					
	Resolution			12		bit
GSM module	Technologies	GSM, UMTS/HSPA+, LTE				
Humidity					90	%
Temperature	Storage without supply				3 *2)	months
	Operational	tA	-20		+45	°C

Use *GSM rele⁵* - DIN inside the rack with IP44 or better!!

*1) Use breaker max. 10 A before *GSM rele⁵*. For power supply 230V_{AC} use lines min. 1 mm².

*2) The *GSM rele⁵* has to be connected to 230V_{AC} power supply every 3 months for 24 hours (due to internal accumulator).

5. Hardware

5.1 Connectors

2 digital inputs, 2 analog inputs and 2 digital outputs can be connected *GSM rele⁵*.

L, N – main power supply 230 V AC

Y5, Y6 – digital outputs

A3, A4 – analog inputs

X1, X2 – digital inputs

Analog inputs can be used for temperature measurement using KTY81-210, PT100 or PT1000 sensor. Length of wires to the sensor is not limited, but be aware of resistivity of these wires. For KTY81-210 16 Ω means 1°C.

ATTENTION: Do not exceed the parameters of inputs and outputs – Chapter **Tech. Specification**.

For examples of connection see the chapter [Examples of connection](#).

5.2 Buttons

GSM rele⁵ has two buttons on front panel for local control of outputs Y5 and Y6. Every click on a button change state of corresponding output. Example: If output Y5 was switched off, after pressing the button Y5 the output will be switched on and after next pressing the output will be switched off again.

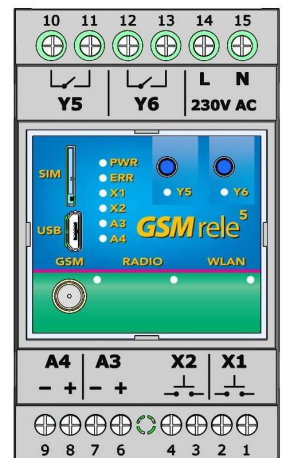

5.3 LED Diodes

The front panel of *GSM rele⁵* contains indication LED diodes **PWR**, **ERR**, **GSM** a LED diodes for indication inputs (X1, X2, A3, A4) and outputs (Y5, Y6):

LED	COLOR	Meaning			
		Off	On	Blink 1 per 3s	1:1
PWR	green	device is off	powered from 230 V AC	powered from backup battery	-
ERR	red	no error	error	-	-
GSM	blue	No GSM signal	-	registered	Searching GSM net
X1 X2	green	Input is not activated	Input is activated	-	-
A3 A4	green	-	-	-	-
Y5 Y6	yellow	Output is disconnected	Output is connected	-	-

5.4 Backup battery

GSM rele⁵ is equipped with backup 3.7 V Li-POL battery which enables to operate the *GSM rele⁵* for several hours in normal mode in case of a 230 V_{AC} power failure (the battery life time depends on mode of usage). During the battery supply mode the *GSM rele⁵* the **LED PWR** blinks at an interval of 1 for 3 seconds. In case of failure of the main power supply, the device can send an SMS message. The settings are made in **SeaConfigurator** – the power supply is listed on the Digital inputs tab under the name **PWW**.

Digital Inputs						
Label	Monitoring and Control	Input activated		Input deactivated		Users
		Name	State L	State H	SMS Message	
X1	<input checked="" type="checkbox"/>	X1	OFF	ON	X1 ON	Novak
X2	<input checked="" type="checkbox"/>	X2	OFF	ON	X2 ON	Novak
PWW	<input checked="" type="checkbox"/>	POWER	POWER	POWER	POWER ON	Novak

5.5 External antenna connector

GSM rele⁵ is supplied with an external antenna GSM-ANT05S with 2,5dB gain. It is not recommended to put this type of antenna on metal surface (the signal quality will degrade). If a *GSM rele⁵* is used in area with a low GSM signal, it's possible to use another type of the antenna with higher gain. See other antennas on www.seapraha.cz.

6. Configuration

Configuration of the *GSM rele⁵* can be made in several ways.

6.1 Default Factory Configuration

When outputs Y5 or Y6 are switched on/off, the *GSM rele⁵* sends an SMS message to the main user (to the telephone number from which it received the first valid command).

The input signal must be stable for certain time (approx. 1 sec) to avoid sending unwanted SMS messages in case of interference on the input.

Temperature regulators are set up so that the OUTPUT Y5 is regulated by temperature sensor on INPUT A3 and OUTPUT Y6 from the temperature sensor on INPUT A4.

6.2 Configuration using PC via USB or GPRS

The configuration (parameter setting) can be changes via SeaConfigurator either via the USB connector (microUSB cable no. HW-11.02 is not included) or through the GPRS connection. This configuration program can be downloaded for free from <http://www.seapraha.cz> (search for „Configurator“) and install it on your PC.

E.g. *GSM rele⁵* can be set to inform of the 230V AC power failure or restoration via SMS.

6.3 Change of configuration via SMS

Some parameters of *GSM rele⁵* can be configured via SMS:

List of configuration SMS commands:

Command	Parameter	Meaning
!FACTORY	-	All parameters are setup to factory default. E.g. Reset to factory default in <i>GSM rele⁵</i> (all custom configuration will be deleted). 1234 !FACTORY
USER ADD	Phone number	Create new user with specified phone number. If phone number is already in the list an error is indicated. If phone number already exists and user is "disabled", User is enabled and no error is indicated. E.g. 1234 USER ADD +420123456789
USER DIS	Phone number	A "disabled" flag for the user is set. If and user is not in the list an error is indicated. E.g. 1234 USER DIS +420123456789
USER CHANGE	Phone number	Changes phone number on different one. If fist phone number isn't there or second one is already int the list an error is indicated. E.g. Change user's phone number from +420111111111 to +420222222222 1234 USER CHANGE+420111111111+420222222222
CODE ADD	Password	New user with specified password is added (password max. 20 digits). If the password already exists an error is indicated. If the password already exists and the user is disabled, the user is activated and no error is indicated. E.g. Add new user with password 9876 1234 CODE ADD 9876
CODE DIS	Password	A "disabled" flag for the code is set. If the user is not in the list an error is indicated. E.g. Disable user with password 9876 from controlling device. 1234 CODE DIS 9876
CODE CHANGE	Password	The first password in the list is replaced by the second password. If the first password does not exist in the list or the second is already in the list an error is indicated. E.g. Change password from 1234 to 9876 1234 CODE CHANGE 1234 9876
X1 !DIS	!DIS !ENA	Disable/enable changes from input/output. (Typical use is when error on input is occurred, on which <i>GSM rele⁵</i> reacts by sending big amount of SMS messages.) E.g. 1234 X1 !DIS ... disables changes from input X1 1234 X2 !ENA ... enables changes from input X2
REGISTER	number	Registration of sender of SMS messages as authorized person who can change settings of <i>GSM rele⁵</i> via GPRS connection. Identification number has to match with number allocated from SeaConfigurator . E.g. 1234 REGISTER 987654

Parameters which can be changed/set via SMS are marked in **SeaConfigurator** in yellow field with symbol of SMS (picture below).By clicking on symbol window with hint will appear.



Caution

When configuring via SMS is important to understand that's only change of parameters and it will not match with configuration saved in PC.



7. Control

7.1 Remote control of GSM rele^s via SMS

GSM rele^s is controlled via SMS of the GSM network. Text SMS are in form:

<PASSWORD> <COMMAND> [<COMMAND >]

Password (access code)

Password is a main security item for **GSM rele^s** control. Command SMS are accepted from any phone number. It means anybody who knows the password and the phone number can control the **GSM rele^s**. The password is a string of digits (1 to 20) which must be on the beginning of any command SMS. Otherwise the SMS will be ignored. A text before the password is automatically ignored. It is useful when command SMS are sent from Internet GSM gates. The password can be changed using SEAConfigurator on the tab General or by a configuration SMS message.

Default password set up by manufacturer:

1234

Command

This part of a message specifies a requested action. See the following table for available commands. **GSM rele^s** commands are not a case sensitive, it's possible to use upper letters as well as lower letters.

Each command is preceded by Yx, where x is the number of controlled output. If output is not specified, the OUTPUT (Y5) is used as default. Commands **ON** and **Y5 ON** and **Y5ON** has the same meaning.

Command	Parameter	Meaning
Y5 ON	-	Switch on output Y5 (Y6 ON switch on output Y6)
ON	-	If no output is specified, switch on output Y5
Y5 OFF	-	Switch off output Y5 (Y6 OFF switch off output Y6)
OFF	-	If no output is specified, switch off output Y5
Y5 PULSE Y5 RESET	5	Switch on output Y5 for 5 seconds creating pulse. Reset output Y5 for 5 seconds.
PULSE RESET		If no output is specified, create 5 sec pulse on output Y5 If no output is specified, reset output Y5
REG	0 to 55	Setting of requested temperature and starts regulation mode. Request of status SMS (state of inputs, outputs, temperatures, signal quality and credit).
STATE	-	Request of status SMS (state of inputs, outputs, temperatures, signal quality and credit).

It's possible to use multiple commands in one message separated by a space.

E.g.

1234 ON ... switch on device connected to output Y5

1234 Y5 ON ... switch on device connected to output Y5

1234 Y6 OFF ... switch off device connected to output Y6

1234 Y6 PULSE 5 ... an OUTPUT Y6 will be switched on and then after 5 seconds will be switched off (Notes: if an output is already switched on, it will be just switched off after 5 seconds)

1234 Y6 reg 5 ... requested temperature for the function temperature regulation of OUTPUT Y6 will be set to + 5°C

Using multiple commands in one SMS message can look like this:

1234 Y5 OFF Y6 REG 25 ... switch off output Y5 and sets temperature regulation on output Y6 to 25 °C according to temperature sensor on input A3.

Confirmation

If a command message contains a valid password (access code) the **GSM rele^s** returns a confirmation message which informs if a command was accepted (see chapter Status SMS). If you don't want a confirmation message (e. g. when sending a command SMS from the Internet GSM gates) add a command "**NOBACK**".

E.g.

1234 Y5 ON NOBACK ... **GSM rele^s** will switch on device on output Y5 and will not send message back.

Command	Meaning
NOBACK	No confirmation SMS will be sent

7.2 Local control of outputs

GSM rele^s has 2 push buttons for local control of outputs Y5 a Y6 (see chapter 5.2).

7.3 Status SMS message

Whenever the command SMS contains valid password the **GSM rele^s** send back Status message.

Example of status SMS message	Meaning
Base station: Y5 ON OK	Command confirmation: Y5 is switched on.
X1=ON	State of input number 1
X2=OFF	State of input number 2
A3=28°C	State of input number 3
A4=5.0V	State of input number 4
Y5=ON	State of output number 1
Y6=OFF	State of output number 2
Power=good	Power state (from battery or power supply)
Battery=100%	State of battery charge
Signal=58%	State of GSM Signal

Note: if value of parameter **Signal** is ??, -- or== It's an error.

7.4 Control using CML (for Smart phones)

This application can use smartphones with Android or iOS. Application makes easier control of **GSM rele^s** and state monitoring. You can download this application from Google Play or Apple Store for free, type into search „**CML SEA**“. After installing the application, make the first registration, take a photo of the QR code of the device into the "paring code". The QR code you find in the **GSM rele^s** package.



WARNING: For the functionality of the CML application, it is necessary to have an activated data tariff on the SIM card, which is inserted in the device. Transferred data can be charged by the operator according to the tariff agreed by you.

7.5 Enable CML

The CML function must be switched on in the GSM-Configurator in „Station settings“, press the edit button in the „CML“ line and check „Enable“ in the CML window.

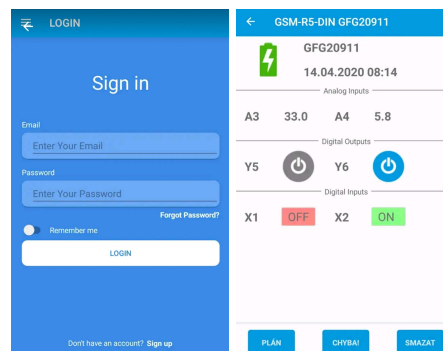

7.6 On-line data on a website

You can monitor the measured values, including the history, and display them clearly on the **cml.seapraha.cz** website. You can also control the outputs or set up e-mails with alarm messages directly from the website.

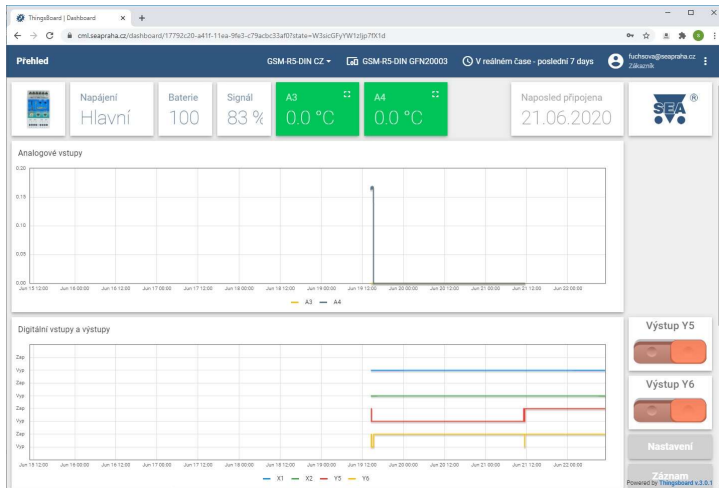

8. Datalogger

GSM relé^S can save (log) detailed information about device's actions. Saving period of analog values is set up in **SeaConfigurator** in settings of the station. Saved log can be used for analyzing activity of device. User can set up which information will be saved to log file during configuration of **LTE-R5-DIN** via **SeaConfigurator**.

It is possible to save information about input/output signals or received/send SMS messages. File type of log file is .csv (= Comma Separated Values). Name of log file is derived from actual date (data.csv).

There are two types of log records: periodic and event. Event record contains actual analog values.

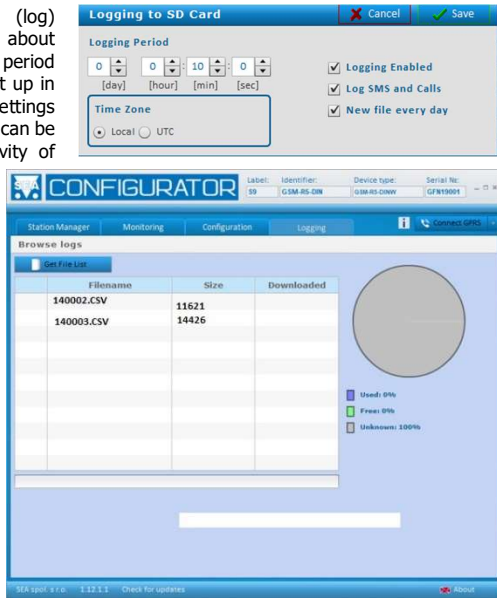

- *1) type (type2) - type of record
- 1 (perio) - periodical record specified by time
- 2 (event) - record about state change of input/output
- 3 (insms) - received SMS
- 4 (outsms) - sent SMS
- 5 (incall) - received SMS
- 6 (outcall) - sent SMS
- 7 (debug) - debug informations (only reason for restart)
- 8 (talk) - play audio (not included)
- 9 (fault) - error
- 32(firmware) - uploading firmware

*3) A1:

- O ... disconnected;
- Z ... short circuit;
- ? ... unknown (Device is not communicating after turning on.)
- [°C] ... unit of measurement

*2) Y.cmd:

- ,R22.6/28.0 - R means regulation current temperature is 22,6°C / required temperature is 28,0°C
- P is pulse
- Q is reset

9. Warranty

General warranty period is 12 months after purchase, when eventual malfunction device will be repaired free of charge in SEA company while shipping to SEA is paid by customer and SEA pays for shipping back to customer. For SW there is 24 months warranty under following conditions:



Both CPU and PC software is sold "as is". The software was created by the best software engineers in SEA and was carefully tested both in SEA and also by SEA customers using GSM applications products made in SEA. In spite of making all possible to get error free software it can happen, that the software in CPU or PC programming SW or their mutual interaction has some error under some specific conditions. If such error is found and the description of the problem including configuration file is sent by E-mail to SEA Ltd., the error is removed free of charge and SEA will send new SW by E-mail to customer.

SEA Ltd. has NO RESPONSIBILITY for any damage, lost, costs and any other problems direct or inducted, caused by such SW error, by eventual device malfunction from any reason or by undelivered SMS from the device.

The manufacturer, seller or installation company is not responsible for the amount of transferred data, connections, telephone calls, sent SMS, MMS, or other charged services of GSM network operators and is not responsible for the amount of fees for GSM network operators of the installed SIM card. Nor is it liable for the energy consumed by the equipment it controls or for any other damage.

CE Declaration of conformity

in accordance with the Radio and Telecommunications Terminal Equipment Directive 1999/5/EC (R&TTE) and Directive 2011/65/EU (ROHS).

We SEA, spol. s r.o., Dolnoměcholupská 1537/21, CZ 102 00 Praha 10, Czech Republic, ID: 47117931 (**manufacturer**) declare under our sole responsibility, that product device for remote control and monitoring type LTE-R5-DIN is in conformity with the following standards:

- health and safety: EN 62368-1:2004
- EMC: EN 61326-1:2013
- radio frequency: EN 301 511 v1.2.5.1, EN 301 489-7 v1.3.1
- ROHS: EN 50581:2012

The last two digits of year in which the CE marking was affixed: 19



Place of issue: Praha
Date of issue: 18.9.2019
Name: Ing. Vladimír Rosůlek
Grade: Technical director

SEA s.r.o. (2)
Společnost pro elektronické aplikace
Dolnoměcholupská 21/96
CZ - 102 00 PRAHA 10 - Hostivař
IČ: 2 727 566 58; IČD: 6302 014 18
KČ: 47117931; DIČ: CZ 47117931

label	Meaning	Example
Time Local	Local date and time when event appears.	2020-04-01 15:32:14
type *1)	Type of saved record (number)	1
type2	Type of saved record (word)	period
phone/ event	Phone number/ Event	+420123456789
text/ action	Text of SMS message / Action	GSM-R5-TI: input is on.
A1[°C] *3)	State of analog input A1	22,6
Y5	State of output Y5	0
Y5.cmd *2)	Output Y5 is regulated to value 28,0 (current value is 22,6)	,R22.6/28.0
X2	State of input X3	1
AP	Analog input "power" [V]	14,4
PWW	Digital input power	1
GSM. cell	Information about BTS	23002F,0404,047A 006E
GSM. sig	Current GSM signal strength [%]	35

10. Examples of connection

10.1 Heating control

Centralized control of loads connected to switchboard is typical for electric heating. Electronic ripple control causes disconnection of electrical heating in time of high tariff. This wiring controls power for electric heater. An electrician would say, that outputs of **GSM rele⁵** are connected into series with centralized control of loads. Outputs of **GSM rele⁵** controls contactors and they control heater and boiler.

On the picture you can see one phase contactors, but three phase contactors can be used as well. – But those could require bigger current through coil. Make sure, that you don't exceed allowed current on outputs of **GSM rele⁵** (see *Technical specifications*).

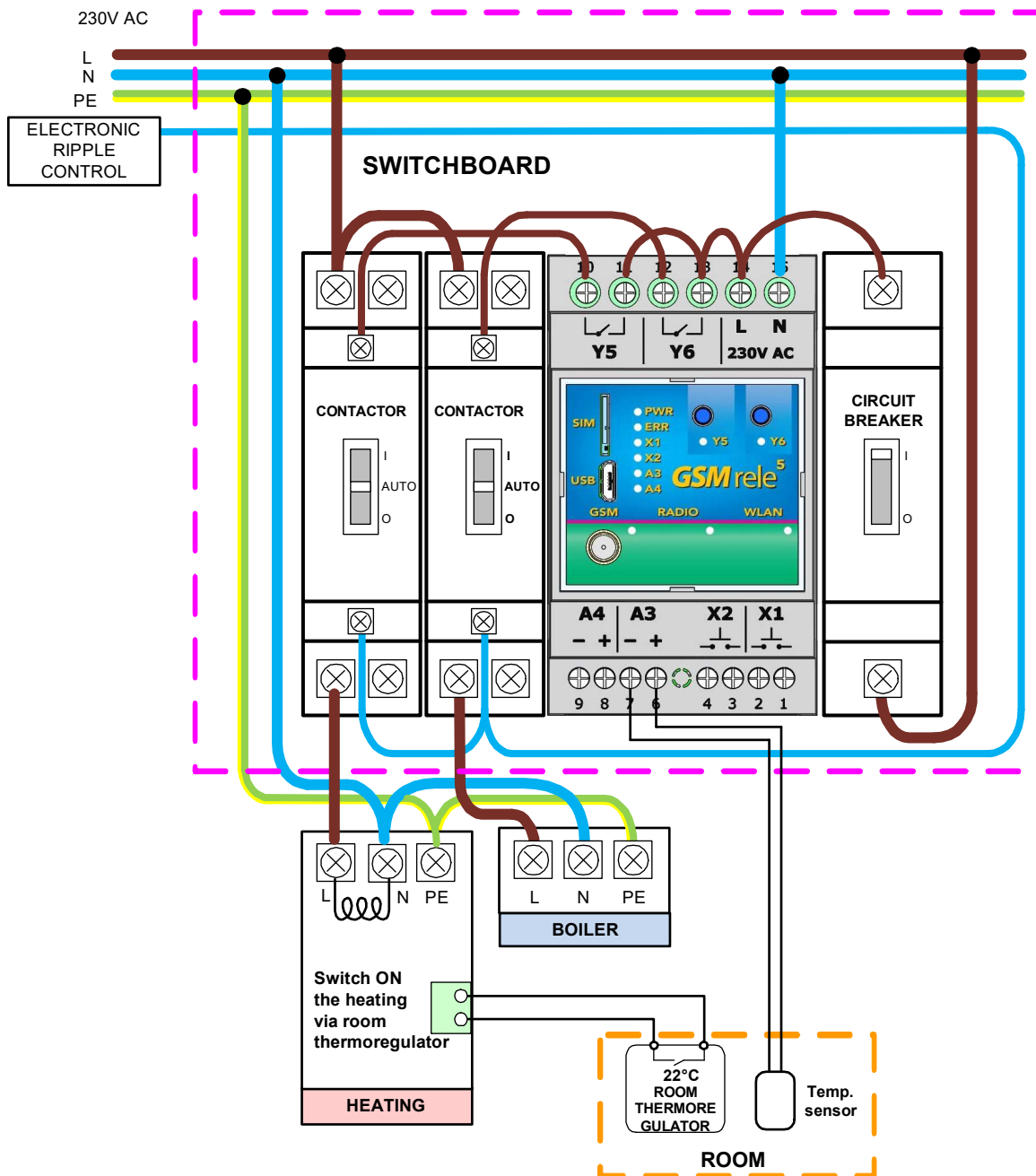

This wiring works like that. Temperature sensor A3 is able to regulate (switch on/off) output V3. Switching output V3 on/off by temperature sensor A3 is set in factory configuration.

In **SeaConfigurator** in settings of output Y5 select freezing temperature (set on 5°C and mark "enabled"). And thermoregulator in room set on comfortable temperature (e.g. 22°C). Heater control wirelessly through commands 1234 Y5 ON (heat up to 22°C) a 1234 Y5 OFF (turn off heater). If temperature drops below 5°C Output Y5 will be switched on and regulates to nonfreezing temperature. If you have enabled heating to freezing temperature in **SeaConfigurator**, you can't switch off heating by command 1234 Y5 OFF. If you need to switch off the heater is possible to disable output by command 1234 Y5 !DIS and then enable again by command 1234 Y5 !EN.

If you want to heat up on higher temperature (for example on 15°C) than is freezing temperature, you can use command 1234 TEPL 15. If selected temperature in command will be higher (e.g. 25°C) than temperature set on thermoregulator, heater will be turned on until it reaches temperature set on thermoregulator (for example on 22°C).

Output Y6 is possible to use for same circuit with heater. (By factory settings output Y4 is regulated by sensor A4.) or it can be used for boiler, eventually for gate control etc.

Temperature alarm setting is independent on temperature regulation (temperature alarm is setting temperature bounds in **SeaConfigurator**, it can send SMS message if temperature drops or exceeds selected temperature).

10.2 Comfortable temperature control

If you need regulate higher temperature than temperature set on thermoregulator. You can use different wiring, where you disable thermoregulator by output Y6.

Command 1234 Y6 OFF will enable thermoregulator A3 to regulate heater. Heater will heat until it reaches selected temperature. Those commands can be sent in one SMS message simultaneously.

Regulation to 25°C	1234 Y6 OFF Y5 TEPL 25	(thermoregulator is disabled)
Regulation to 22°C	1234 Y6 ON Y5 OFF	(thermoregulator is set to 22°C)
Regulation to 7°C	1234 TEPL 7	(thermoregulator is disabled)

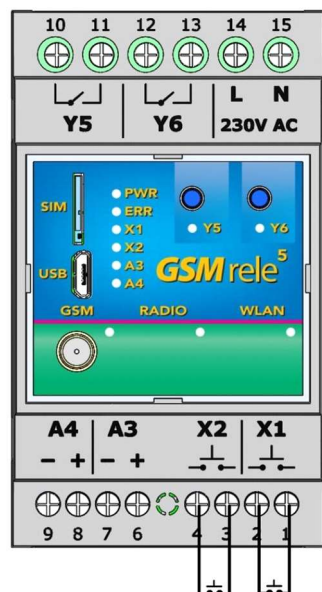
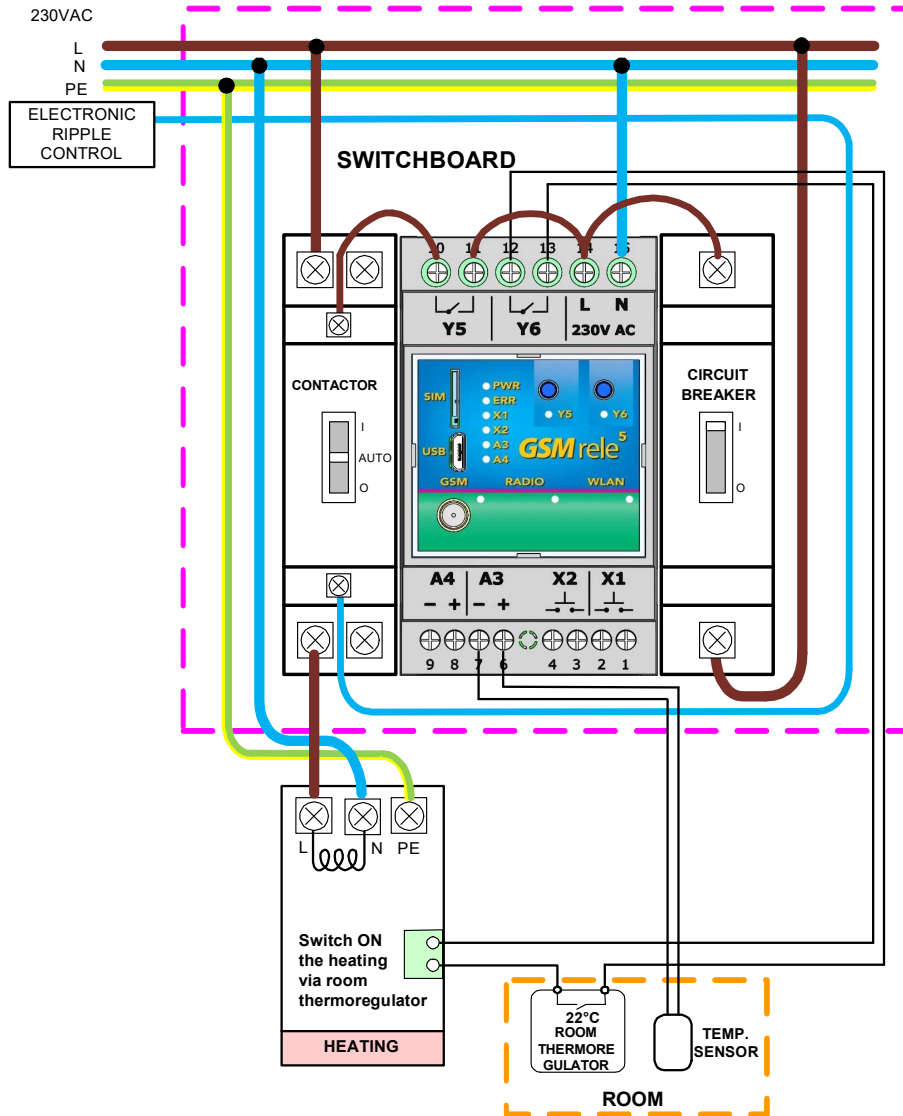

10.3 Digital inputs

Example of connection of inputs X1 and X2 as contact status detector:

If you need to monitor a potential free contacts (for example magnetic contacts of the alarm circuit or relay contacts), connect them directly to inputs X1 and X2.

11. Frequently Asked Questions (FAQ)

What is necessary to use the *GSM rele^S*:

- Good quality GSM signal in a place where *GSM rele^S* will be used (at least 2 bars on your mobile phone)
- Sufficient credit on a pre-paid SIM card
- No phone call redirection
- The user has to know to operate his mobile phone (PIN usage deactivation)
- Note: Users who knows to operate older version of GSM RELAY version 2 can use older SMS command form: E.g. 1234 ON3 OFF4

Problem description	Possible reason	Solution
<p>LED GSM (blue) flashes 1:1 (slow)</p> <p>LED GSM (blue) is off (dark)</p> <p>LED ERROR (red) is on (lights permanently)</p>	<p>SIM card is not functional</p> <p>New SIM card is not activated yet</p> <p>Low credit on a pre-paid SIM card</p> <p>Weak/poor GSM signal</p>	<p>Test the SIM card in your mobile phone. Try to make a call and receive a call from another mobile phone. Try to send a receive SMS message. Switch off using PIN on a SIM card. Cancel all call redirection for a SIM card. (Ask your mobile operator for help if necessary).</p> <p>New SIM card has to be activated. (Ask your mobile operator for help if necessary).</p> <p>Check credit on a pre-paid SIM card. (Ask your mobile operator for help if necessary).</p> <p>Test the SIM card in your mobile phone. The mobile phone should show the signal level at least 2 bars.</p>
<p>The pulse on an output is not generated based on incoming ring signal (e. g. for a gate opening)</p>	<p>The incoming phone calls for a SIM card are redirected</p>	<p>Cancel all phone call redirections for the SIM card</p>
<p><i>GSM rele^S</i> sends SMS message, that „connection to configuration server failed: error 5/0 0,1,1“</p>	<p>GPRS connection was interrupted, when <i>GSM rele^S</i> ring user, who doesn't react for too long.</p>	<p>Restore GPRS connection from SeaConfigurator.</p>
<p>The temperature from an external temperature sensor is wrong. Too long lines to an external temperature sensor.</p>	<p>Too long lines to an external temperature sensor</p>	<p>The accuracy of temperature depends on a line length to an external temperature sensor (16 Ohms means 1°C). Use thicker wires to temperature sensor.</p>